

NTGS3433T1

MOSFET -3.3 Amps, -12 Volts P-Channel TSOP-6

Features

- Ultra Low $R_{DS(on)}$
- Higher Efficiency Extending Battery Life
- Miniature TSOP-6 Surface Mount Package

Applications

- Power Management in Portable and Battery-Powered Products, i.e.: Cellular and Cordless Telephones, and PCMCIA Cards

MAXIMUM RATINGS ($T_J = 25^\circ\text{C}$ unless otherwise noted.)

Rating	Symbol	Value	Unit
Drain-to-Source Voltage	V_{DSS}	-12	Volts
Gate-to-Source Voltage - Continuous	V_{GS}	± 8.0	Volts
Thermal Resistance Junction-to-Ambient (Note 1)	$R_{\theta JA}$	62.5	$^\circ\text{C/W}$
Total Power Dissipation @ $T_A = 25^\circ\text{C}$	P_d	2.0	Watts
Drain Current - Continuous @ $T_A = 25^\circ\text{C}$	I_D	-3.3	Amps
- Pulsed Drain Current ($T_p < 10 \mu\text{s}$)	I_{DM}	-20	Amps
Maximum Operating Power Dissipation	P_d	1.0	Watts
Maximum Operating Drain Current	I_D	-2.35	Amps
Thermal Resistance Junction-to-Ambient (Note 2)	$R_{\theta JA}$	128	$^\circ\text{C/W}$
Total Power Dissipation @ $T_A = 25^\circ\text{C}$	P_d	1.0	Watts
Drain Current - Continuous @ $T_A = 25^\circ\text{C}$	I_D	-2.35	Amps
- Pulsed Drain Current ($T_p < 10 \mu\text{s}$)	I_{DM}	-14	Amps
Maximum Operating Power Dissipation	P_d	0.5	Watts
Maximum Operating Drain Current	I_D	-1.65	Amps
Operating and Storage Temperature Range	T_J, T_{stg}	-55 to 150	$^\circ\text{C}$
Maximum Lead Temperature for Soldering Purposes for 10 Seconds	T_L	260	$^\circ\text{C}$

- 1 Mounted onto a 2" square FR-4 board (1" sq. 2 oz. cu. 0.06" thick single sided), $t < 5.0$ seconds.
- 2 Mounted onto a 2" square FR-4 board (1" sq. 2 oz. cu. 0.06" thick single sided), operating to steady state.



ON Semiconductor®

<http://onsemi.com>

V_{DSS}	$R_{DS(ON)}$ TYP	I_D MAX
-12 V	75 m Ω @ $V_{GS} = -4.5$ V	-3.3 A

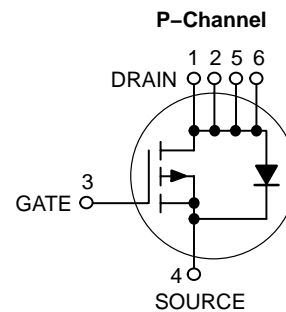

TSOP-6
CASE 318G
STYLE 1

MARKING DIAGRAM

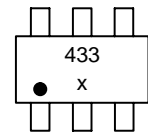

433 = Device Code
x = Date Code

PIN ASSIGNMENT

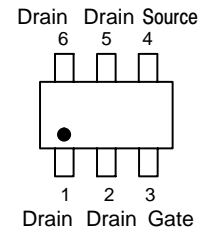

ORDERING INFORMATION

Device	Package	Shipping†
NTGS3433T1	TSOP-6	3000 Tape & Reel

†For information on tape and reel specifications, including part orientation and tape sizes, please refer to our Tape and Reel Packaging Specification Brochure, BRD8011/D.

NTGS3433T1

ELECTRICAL CHARACTERISTICS (T_A = 25°C unless otherwise noted) (Notes 3 & 4)

Characteristic	Symbol	Min	Typ	Max	Unit
----------------	--------	-----	-----	-----	------

OFF CHARACTERISTICS

Drain-Source Breakdown Voltage (V _{GS} = 0 Vdc, I _D = -10 μA)	V _{(BR)DSS}	-12	-	-	Vdc
Zero Gate Voltage Drain Current (V _{GS} = 0 Vdc, V _{DS} = -8 Vdc, T _J = 25°C) (V _{GS} = 0 Vdc, V _{DS} = -8 Vdc, T _J = 70°C)	I _{DSS}	-	-	-1.0 -5.0	μAdc
Gate-Body Leakage Current (V _{GS} = -8.0 Vdc, V _{DS} = 0 Vdc)	I _{GSS}	-	-	-100	nAdc
Gate-Body Leakage Current (V _{GS} = +8.0 Vdc, V _{DS} = 0 Vdc)	I _{GSS}	-	-	100	nAdc

ON CHARACTERISTICS

Gate Threshold Voltage (V _{DS} = V _{GS} , I _D = -250 μAdc)	V _{GS(th)}	-0.50	-0.70	-1.50	Vdc
Static Drain-Source On-State Resistance (V _{GS} = -4.5 Vdc, I _D = -3.3 Adc) (V _{GS} = -2.5 Vdc, I _D = -2.9 Adc)	R _{DS(on)}	-	0.055 0.075	0.075 0.095	Ω
Forward Transconductance (V _{DS} = -10 Vdc, I _D = -3.3 Adc)	g _{FS}	-	7.0	-	mhos

DYNAMIC CHARACTERISTICS

Total Gate Charge	(V _{DS} = -10 Vdc, V _{GS} = -4.5 Vdc, I _D = -3.3 Adc)	Q _{tot}	-	7.0	15	nC
Gate-Source Charge		Q _{gs}	-	2.0	-	
Gate-Drain Charge		Q _{gd}	-	3.5	-	
Input Capacitance	(V _{DS} = -5.0 Vdc, V _{GS} = 0 Vdc, f = 1.0 MHz)	C _{iss}	-	550	-	pF
Output Capacitance		C _{oss}	-	450	-	
Reverse Transfer Capacitance		C _{rss}	-	200	-	

SWITCHING CHARACTERISTICS

Turn-On Delay Time	(V _{DD} = -10 Vdc, I _D = -1.0 Adc, V _{GS} = -4.5 Vdc, R _g = 6.0 Ω)	t _{d(on)}	-	20	30	ns
Rise Time		t _r	-	20	30	
Turn-Off Delay Time		t _{d(off)}	-	110	120	
Fall Time		t _f	-	100	115	
Reverse Recovery Time	(I _S = -1.7 Adc, di _S /dt = 100 A/μs)	t _{rr}	-	30	-	ns

BODY-DRAIN DIODE RATINGS

Diode Forward On-Voltage	(I _S = -1.7 Adc, V _{GS} = 0 Vdc)	V _{SD}	-	-0.80	-1.5	Vdc
Diode Forward On-Voltage	(I _S = -3.3 Adc, V _{GS} = 0 Vdc)	V _{SD}	-	-0.90	-	Vdc

3. Indicates Pulse Test: P.W. = 300 μsec max, Duty Cycle = 2%.

4. Class 1 ESD rated – Handling precautions to protect against electrostatic discharge is mandatory.

NTGS3433T1

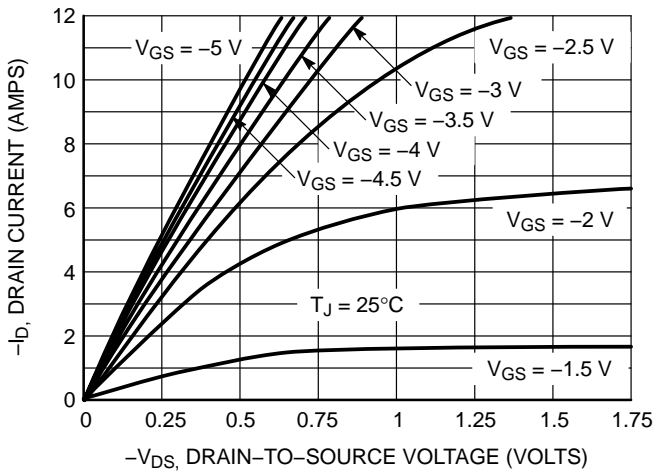

Figure 1. On-Region Characteristics

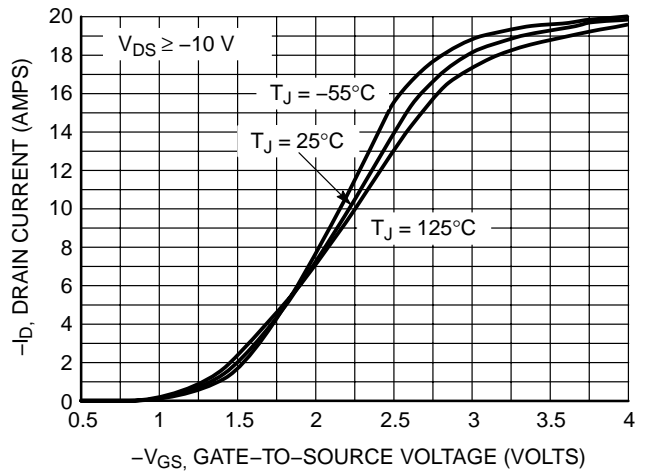

Figure 2. Transfer Characteristics

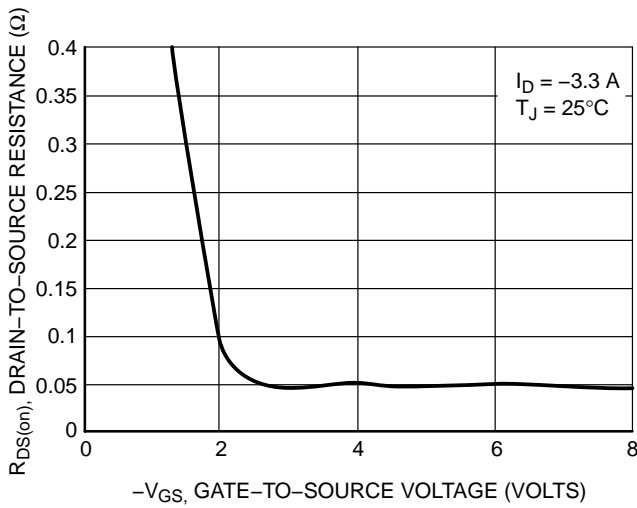

Figure 3. On-Resistance vs. Gate-to-Source Voltage

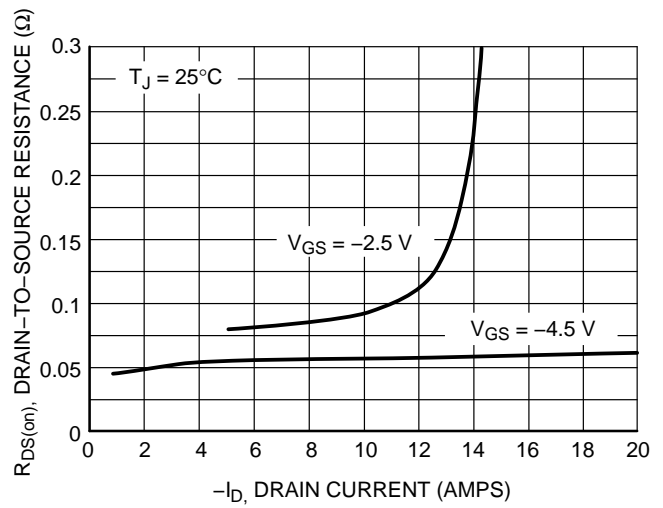

Figure 4. On-Resistance vs. Drain Current and Gate Voltage

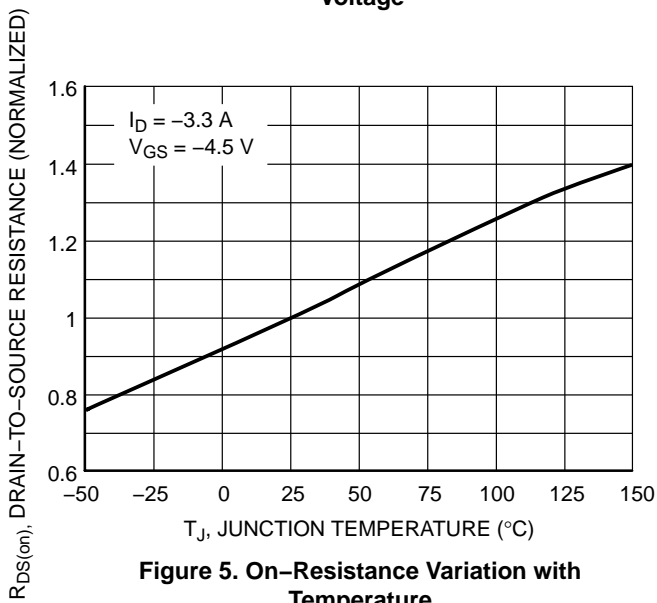

Figure 5. On-Resistance Variation with Temperature

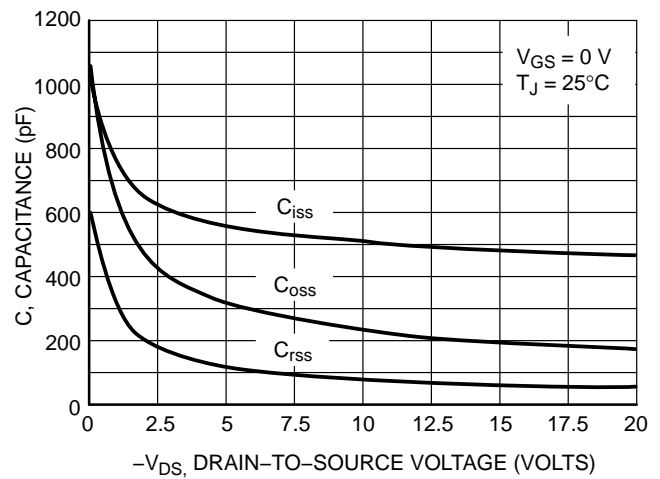

Figure 6. Capacitance Variation

NTGS3433T1

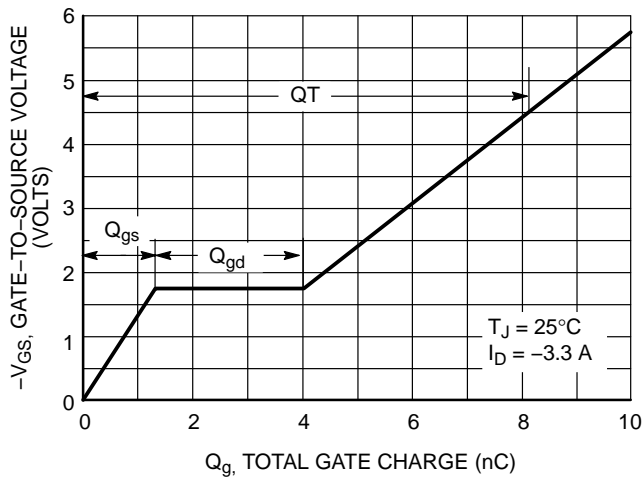

Figure 7. Gate-to-Source and Drain-to-Source Voltage vs. Total Charge

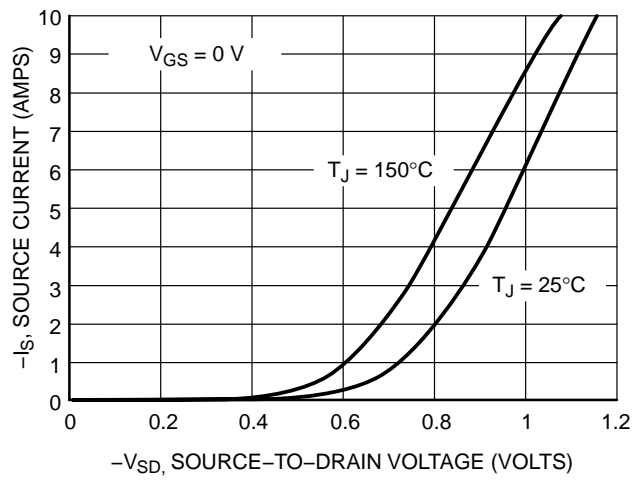

Figure 8. Diode Forward Voltage vs. Current

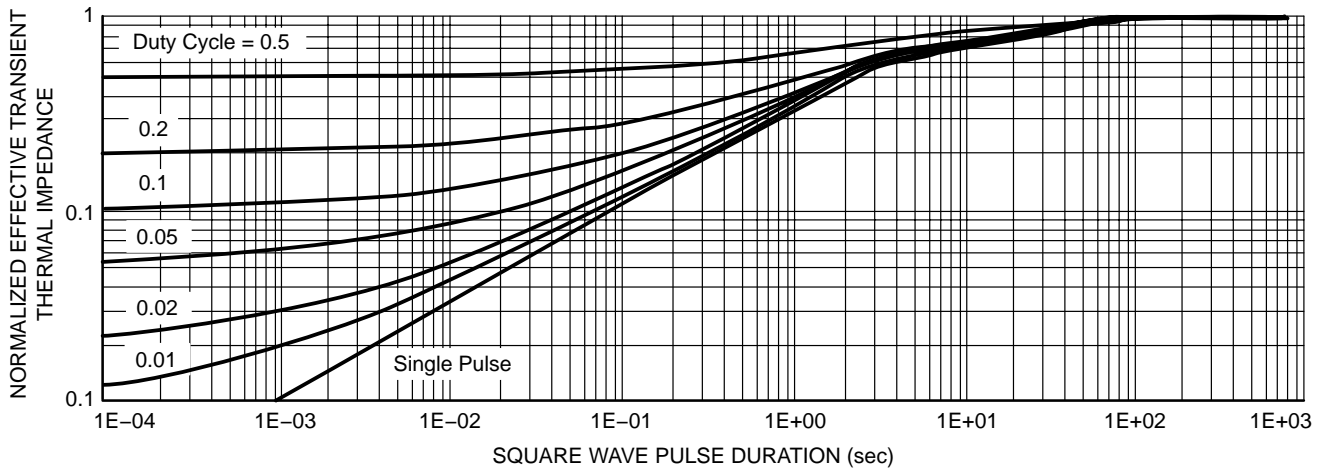

Figure 9. Normalized Thermal Transient Impedance, Junction-to-Ambient

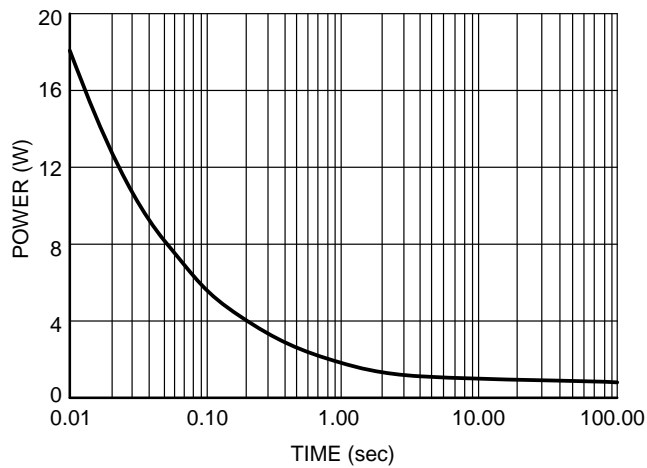
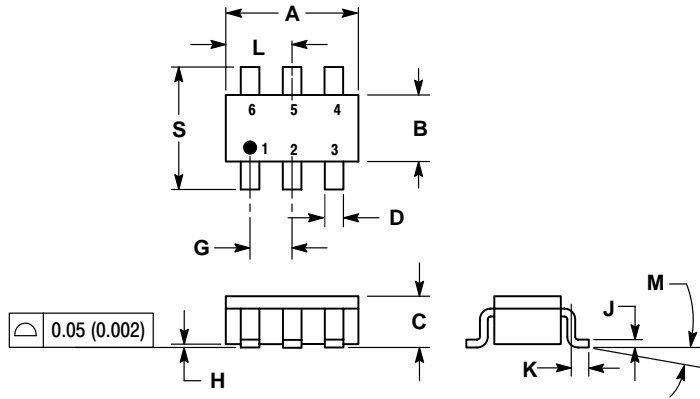

Figure 10. Single Pulse Power

NTGS3433T1

PACKAGE DIMENSIONS

TSOP-6
CASE 318G-02
ISSUE L



NOTES:

1. DIMENSIONING AND TOLERANCING PER ANSI Y14.5M, 1982.
2. CONTROLLING DIMENSION: MILLIMETER.
3. MAXIMUM LEAD THICKNESS INCLUDES LEAD FINISH THICKNESS. MINIMUM LEAD THICKNESS IS THE MINIMUM THICKNESS OF BASE MATERIAL.
4. DIMENSIONS A AND B DO NOT INCLUDE MOLD FLASH, PROTRUSIONS, OR GATE BURRS.

DIM	MILLIMETERS		INCHES	
	MIN	MAX	MIN	MAX
A	2.90	3.10	0.1142	0.1220
B	1.30	1.70	0.0512	0.0669
C	0.90	1.10	0.0354	0.0433
D	0.25	0.50	0.0098	0.0197
G	0.85	1.05	0.0335	0.0413
H	0.013	0.100	0.0005	0.0040
J	0.10	0.26	0.0040	0.0102
K	0.20	0.60	0.0079	0.0236
L	1.25	1.55	0.0493	0.0610
M	0°	10°	0°	10°
S	2.50	3.00	0.0985	0.1181

STYLE 1:

1. DRAIN
2. DRAIN
3. GATE
4. SOURCE
5. DRAIN
6. DRAIN

SOLDERING FOOTPRINT*

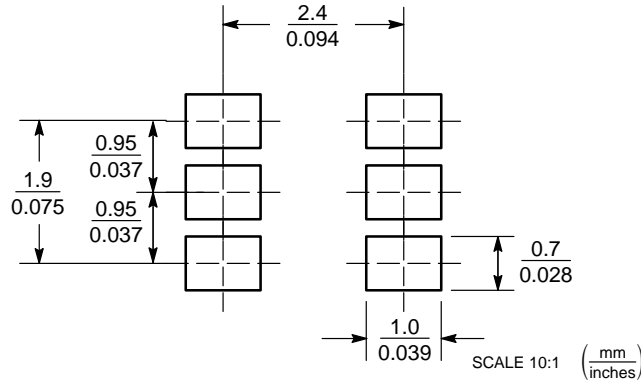

*For additional information on our Pb-Free strategy and soldering details, please download the ON Semiconductor Soldering and Mounting Techniques Reference Manual, SOLDERRM/D.

ON Semiconductor and  are registered trademarks of Semiconductor Components Industries, LLC (SCILLC). SCILLC reserves the right to make changes without further notice to any products herein. SCILLC makes no warranty, representation or guarantee regarding the suitability of its products for any particular purpose, nor does SCILLC assume any liability arising out of the application or use of any product or circuit, and specifically disclaims any and all liability, including without limitation special, consequential or incidental damages. "Typical" parameters which may be provided in SCILLC data sheets and/or specifications can and do vary in different applications and actual performance may vary over time. All operating parameters, including "Typicals" must be validated for each customer application by customer's technical experts. SCILLC does not convey any license under its patent rights nor the rights of others. SCILLC products are not designed, intended, or authorized for use as components in systems intended for surgical implant into the body, or other applications intended to support or sustain life, or for any other application in which the failure of the SCILLC product could create a situation where personal injury or death may occur. Should Buyer purchase or use SCILLC products for any such unintended or unauthorized application, Buyer shall indemnify and hold SCILLC and its officers, employees, subsidiaries, affiliates, and distributors harmless against all claims, costs, damages, and expenses, and reasonable attorney fees arising out of, directly or indirectly, any claim of personal injury or death associated with such unintended or unauthorized use, even if such claim alleges that SCILLC was negligent regarding the design or manufacture of the part. SCILLC is an Equal Opportunity/Affirmative Action Employer. This literature is subject to all applicable copyright laws and is not for resale in any manner.

PUBLICATION ORDERING INFORMATION

LITERATURE FULFILLMENT:

Literature Distribution Center for ON Semiconductor
P.O. Box 5163, Denver, Colorado 80217 USA

Phone: 303-675-2175 or 800-344-3860 Toll Free USA/Canada

Fax: 303-675-2176 or 800-344-3867 Toll Free USA/Canada

Email: orderlit@onsemi.com

N. American Technical Support: 800-282-9855 Toll Free
USA/Canada

Japan: ON Semiconductor, Japan Customer Focus Center

2-9-1 Kamimeguro, Meguro-ku, Tokyo, Japan 153-0051

Phone: 81-3-5773-3850

ON Semiconductor Website: <http://onsemi.com>

Order Literature: <http://www.onsemi.com/litorder>

For additional information, please contact your
local Sales Representative.